UNIT 2: FIRE SAFETY AND UTILITY CONTROLS

In this unit you will learn about:

- **Fire Chemistry: How fire occurs, classes of fire, and choosing the correct means to extinguish each type of fire.**
- **Fire and Utility Hazards: Potential fire and utility hazards in the home and workplace, and fire prevention strategies.**

- **CERT Sizeup:** How to conduct the continual data-gathering and evaluation process at the scene of a disaster or emergency.
- **Fire Sizeup Considerations:** How to evaluate fires, assess firefighting resources, and determine a course of action.
- **Portable Fire Extinguishers:** Types of portable fire extinguishers and how to operate them.
- **Fire Suppression Safety:** How to decide if you should attempt to extinguish a fire; how to approach and extinguish a fire safely.
- **Hazardous Materials:** How to identify potentially dangerous materials in storage, in transit, and in your home.

COMMUNITY EMERGENCY RESPONSE TEAM
UNIT 2: FIRE SAFETY AND UTILITY CONTROLS

INTRODUCTION AND UNIT OVERVIEW

During, and immediately following a severe emergency, the first priorities of professional fire services are life safety and extinguishing *major* fires.

They may be hampered by impassable roads, weather conditions, inadequate water supply, and other inadequate resources.

COMMUNITY EMERGENCY RESPONSE TEAM
UNIT 2: FIRE SAFETY AND UTILITY CONTROLS

UNIT TOPICS

This unit will provide you with the knowledge and skills that you will need to reduce or eliminate fire hazards and extinguish small fires.

The areas that you will learn about include:

- **Fire chemistry**
- **Fire and utility hazards in the home, workplace, and neighborhood**
- **CERT sizeup**
- **Fire sizeup considerations**
- **Firefighting resources**
- **Fire suppression safety**
- **Hazardous materials**

At the end of the unit, you will have an opportunity to use a portable extinguisher to put out a fire.

COMMUNITY EMERGENCY RESPONSE TEAM
UNIT 2: FIRE SAFETY AND UTILITY CONTROLS

- **Shutting off utilities when necessary and safe to do so**
 - This unit will review utility shutoff procedures taught in Unit 1.
- **Assisting with evacuations where necessary**
 - When a fire is beyond the ability of CERTs to extinguish or a utility emergency has occurred, CERT members need to protect lives by evacuating the area and establishing a perimeter.

CERT PRIORITIES

CERTs play a very important role in neighborhood and workplace fire and utility safety. CERT members help in fire- and utility-related emergencies before professional responders arrive. When responding, CERT members should keep in mind the following CERT standards:

COMMUNITY EMERGENCY RESPONSE TEAM
UNIT 2: FIRE SAFETY AND UTILITY CONTROLS

FIRE CHEMISTRY

FIRE CHEMISTRY

Fire requires three elements to exist:

- **Heat**: Heat is required to elevate the temperature of a material to its ignition point.
- **Fuel**: The fuel for a fire may be a solid, liquid, or gas. The type and quantity of the fuel will determine which method should be used to extinguish the fire.
- **Oxygen**: Most fires will burn vigorously in any atmosphere of at least 20 % oxygen. Without oxygen, most fuels could be heated until entirely vaporized, yet would not burn.

These three elements, called the *fire triangle*, create a chemical exothermic reaction, which is fire.

COMMUNITY EMERGENCY RESPONSE TEAM
UNIT 2: FIRE SAFETY AND UTILITY CONTROLS

CLASSES OF FIRE

To aid in extinguishing fires, fires are categorized into classes based on the type of fuel that is burning:

- **Class A Fires**: Ordinary combustibles such as paper, cloth, wood, rubber, and many plastics
- **Class B Fires**: Flammable liquids (e.g., oils, gasoline) and combustible liquids (e.g., charcoal lighter fluid, kerosene). These fuels burn only at the surface because oxygen cannot penetrate the depth of the fluid. Only the vapor burns when ignited.
- **Class C Fires**: Energized electrical equipment (e.g., wiring, motors). When the electricity is turned off, the fire becomes a Class A fire.
- **Class D Fires**: Combustible metals (e.g., aluminum, magnesium, titanium)
- **Class K Fires**: Cooking oils (e.g., vegetable oils, animal oils, fats)

It is extremely important to identify the type of fuel

COMMUNITY EMERGENCY RESPONSE TEAM
UNIT 2: FIRE SAFETY AND UTILITY CONTROLS

Simple fire prevention measures will help reduce the likelihood of fires:

- **First, *locate* potential sources of ignition.**
- **Then, do what you can to *reduce or eliminate* the hazards.**

ELECTRICAL HAZARDS

Here are some examples of common electrical hazards and simple ways that they can be reduced or eliminated:

- **Avoid the “electrical octopus.” Eliminate tangles of electrical cords. Don’t overload electrical outlets. Don’t plug power strips into other power strips.**
- **Don’t run electrical cords under carpets.**
- **Check for and replace broken or frayed cords immediately.**

COMMUNITY EMERGENCY RESPONSE TEAM
UNIT 2: FIRE SAFETY AND UTILITY CONTROLS

You should not enter a flooded basement or standing water to shut off the electrical supply because water conducts electricity.

COMMUNITY EMERGENCY RESPONSE TEAM
UNIT 2: FIRE SAFETY AND UTILITY CONTROLS

CIRCUIT BOX AND FUSE BOX

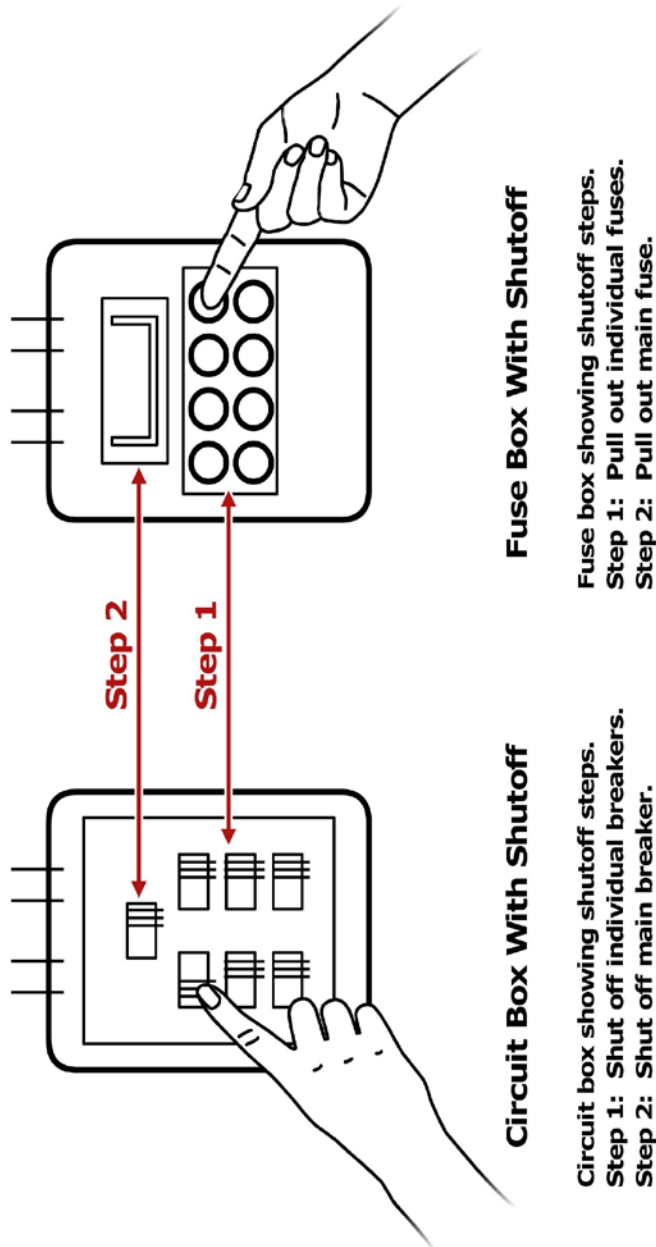

COMMUNITY EMERGENCY RESPONSE TEAM
UNIT 2: FIRE SAFETY AND UTILITY CONTROLS

NATURAL GAS HAZARDS

Natural gas presents two types of hazards. It is an:

- **Asphyxiant** that robs the body of oxygen
- **Explosive** that can easily ignite

NATURAL GAS HAZARD AWARENESS

Here are several examples for monitoring natural gas in your home:

- **As with smoke alarms that need to be strategically placed in your home, e.g., on every level of the home and near all sleeping areas, install a natural gas detector near the furnace, hot water tank, and gas appliances such as clothes dryer or stove. Test the detector monthly to ensure that it works.**
- **Install a carbon monoxide detector near the sleeping area. Additional detectors may be installed on every level of the home and in every bedroom. Detectors should not be placed within 15 feet of**

COMMUNITY EMERGENCY RESPONSE TEAM
UNIT 2: FIRE SAFETY AND UTILITY CONTROLS

NATURAL GAS METER WITH SHUTOFF

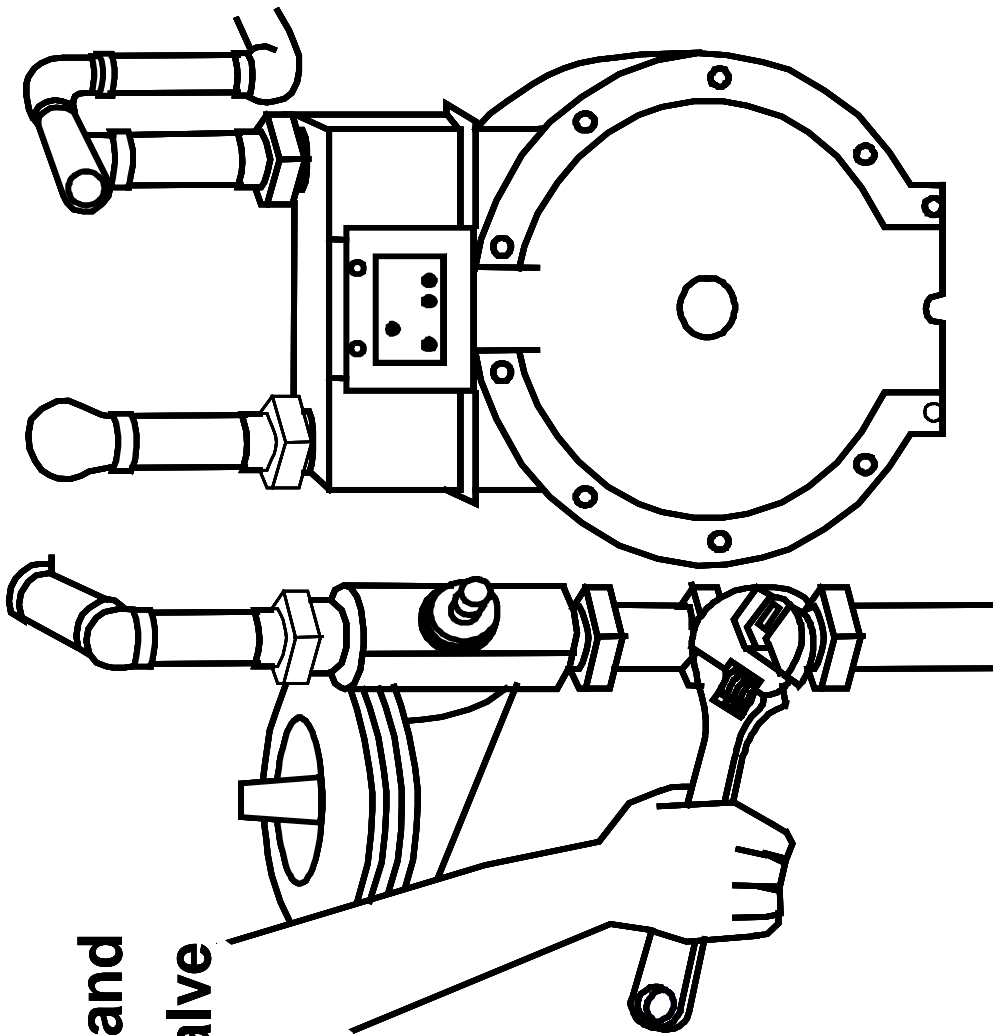

**Gas meter and
shut-off valve**

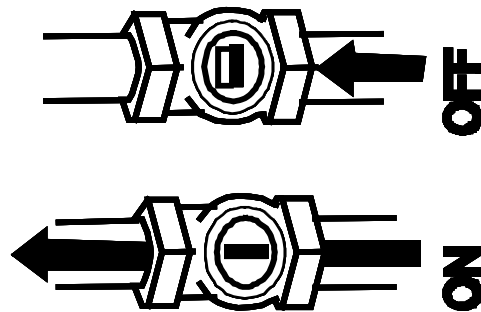

COMMUNITY EMERGENCY RESPONSE TEAM
UNIT 2: FIRE SAFETY AND UTILITY CONTROLS

GAS SHUTOFF

Gas meter inside the home

If your gas meter is located inside your home, you should only shut off gas flow when instructed to by local authorities. If you smell gas or see the dials on your meter showing gas is flowing even though appliances are turned off, you should evacuate the premises and call 911. Do not attempt to shut off the gas from inside the building if gas may be in the air.

Gas meter outside the home

You should turn off the meter from outside the building if you smell gas or you see dials on the meter showing gas is flowing even though appliances are turned off. If there is a fire that you cannot extinguish, call 911 and turn off the gas only if it is safe to do so.

If you are unsure of the proper procedures, do not attempt to turn the utilities on again yourself,

COMMUNITY EMERGENCY RESPONSE TEAM
UNIT 2: FIRE SAFETY AND UTILITY CONTROLS

FLAMMABLE LIQUID HAZARDS

Here are several examples for reducing hazards from flammable liquids:

- **Read labels to identify flammable products.**
- **Store them properly, using the L.I.E.S. method (Limit, Isolate, Eliminate, Separate).**

You should only extinguish a flammable liquid using a portable fire extinguisher rated for Class B fires.

COMMUNITY EMERGENCY RESPONSE TEAM
UNIT 2: FIRE SAFETY AND UTILITY CONTROLS

- 3. Consider probabilities. What is likely to happen? What could happen through cascading events?**
- 4. Assess your own situation. Are you in immediate danger? Have you been trained to handle the situation? Do you have the equipment that you need?**
- 5. Establish priorities. Are lives at risk? Can you help? Remember, life safety is the first priority!**
- 6. Make decisions. Base your decisions on the answers to Steps 1 through 5 and in accordance with the priorities that you established.**
- 7. Develop a plan of action. Develop a plan that will help you accomplish your priorities. Simple plans may be verbal, but more complex plans should always be written.**

COMMUNITY EMERGENCY RESPONSE TEAM
UNIT 2: FIRE SAFETY AND UTILITY CONTROLS

CERT FIRE SIZEUP

	Yes	No
Step 1: Gather Facts		
<i>Time</i>		
<ul style="list-style-type: none">▪ Does the time of day or week affect fire suppression efforts? How?	<input type="checkbox"/>	<input type="checkbox"/>
<i>Weather</i>		
<ul style="list-style-type: none">▪ Are there weather conditions that affect your safety? If yes, how will your safety be affected?	<input type="checkbox"/>	<input type="checkbox"/>

COMMUNITY EMERGENCY RESPONSE TEAM
UNIT 2: FIRE SAFETY AND UTILITY CONTROLS

<p>▪ Are there special considerations (e.g., children, elderly, pets, people with disabilities)?</p>	<input type="checkbox"/>	<input type="checkbox"/>
<p><i>Hazards</i></p>		
<p>▪ Are hazardous materials evident?</p>	<input type="checkbox"/>	<input type="checkbox"/>
<p>▪ Are any other types of hazards present?</p> <p>If yes, what other hazards?</p>	<input type="checkbox"/>	<input type="checkbox"/>

COMMUNITY EMERGENCY RESPONSE TEAM
UNIT 2: FIRE SAFETY AND UTILITY CONTROLS

If yes, what are the hazards?		
<i>Path of Fire</i>		
<ul style="list-style-type: none"> ▪ Does the fire’s path jeopardize other areas? If yes, what other areas may be jeopardized? 	<input type="checkbox"/>	<input type="checkbox"/>
<i>Additional Damage</i>		
<ul style="list-style-type: none"> ▪ Is there a high potential for more disaster activity that will impact personal safety? If yes, what are the known risks? 	<input type="checkbox"/>	<input type="checkbox"/>

COMMUNITY EMERGENCY RESPONSE TEAM
UNIT 2: FIRE SAFETY AND UTILITY CONTROLS

Step 6: Make Decisions

- **Where will resources do the most good while maintaining an adequate margin of safety?**

Step 7: Develop a Plan of Action

- **Determine how personnel and other resources should be used.**

Step 8: Take Action

- **Put the plan into effect.**

Step 9: Evaluate Progress

- **Continually size up the situation to identify changes in the:**
 - **Scope of the problem**
 - **Safety risks**
 - **Resource availability**
- **Adjust strategies as required.**

COMMUNITY EMERGENCY RESPONSE TEAM
UNIT 2: FIRE SAFETY AND UTILITY CONTROLS

FIREFIGHTING RESOURCES

The most common firefighting resources are:

- **Portable fire extinguishers**
- **Interior wet standpipes**

Other resources include confinement and “creative resources.”

FIRE EXTINGUISHERS







Portable fire extinguishers are invaluable for putting out small fires. A well-prepared home or workplace will have at least two portable fire extinguishers of the appropriate type for the location.

Keep in mind that the type of fuel that is burning will determine which resources to select to fight a fire.

Because portable fire extinguishers are most common, this section will focus on them.

COMMUNITY EMERGENCY RESPONSE TEAM
UNIT 2: FIRE SAFETY AND UTILITY CONTROLS

Fire Types, Extinguishing Agents, and Methods

FIRE TYPE	EXTINGUISHING AGENT	EXTINGUISHING METHOD
Ordinary Solid Materials  	Water	Removes heat
	Foam	Removes air and heat
	Dry chemical	Breaks chain reaction
Flammable Liquids  	Foam CO₂	Removes air
	Foam Dry chemical	Breaks chain reaction
Electrical Equipment  	CO₂	Removes air
	Dry chemical	Breaks chain reaction

COMMUNITY EMERGENCY RESPONSE TEAM
UNIT 2: FIRE SAFETY AND UTILITY CONTROLS

EXTINGUISHER RATING AND LABELING

Portable fire extinguishers must be rated and approved by the State fire marshal and Underwriters Laboratories (an organization that sets safety standards for manufactured goods). They are rated according to their effectiveness on the different classes of fire. Their strength and capability must also be labeled by the manufacturer.

The label contains vital information about the type(s) of fire for which the extinguisher is appropriate.

Extinguishers that are appropriate for Class A fires have a rating from 1A to 40A, with a higher number indicating a higher volume of extinguishing agent.

Extinguishers that are appropriate for Class B fires have a rating from 1B to 640B.

No number accompanies an extinguisher rated Class C, D, or K.

COMMUNITY EMERGENCY RESPONSE TEAM
UNIT 2: FIRE SAFETY AND UTILITY CONTROLS

MANUFACTURER'S LABEL ILLUSTRATION

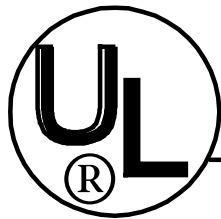

**UNDERWRITERS
LABORATORIES**

INC. (R)

**DRY CHEMICAL FIRE EXTINGUISHER
CLASSIFICATION 3A:40B:C
TESTED IN ACCORDANCE WITH
ANSI/UL 711 AND ANSI/UL 299**

NO.

**MARINE TYPE U.S.C.G. TYPE A SIZE II TYPE B:C SIZE I
U.S.C.G. APPROVAL NO. 162.028/EX-2480
VALID ONLY WITH BRACKET NO. A-6**

COMMUNITY EMERGENCY RESPONSE TEAM
UNIT 2: FIRE SAFETY AND UTILITY CONTROLS

CHEMICAL EXTINGUISHERS

Dry chemical extinguishers are most common.

- **Dry chemical extinguishers have a sodium bicarbonate base and are effective on Class B and C fires.**
- **Multipurpose dry chemical extinguishers have a monoammonium phosphate base and are effective for Class A, B, and C fires.**

Common characteristics of dry chemical extinguishers include:

- **Capacity. Approximately 10-20 seconds discharge time**
- **Range. Standard range is 8-12 feet.**
- **Pressure. Standard pressure is 175-250 psi.**

While still in use, carbon dioxide and other specialized extinguishers are becoming less common.

COMMUNITY EMERGENCY RESPONSE TEAM
UNIT 2: FIRE SAFETY AND UTILITY CONTROLS

- **Shut all doors as you leave to slow the spread of the fire.**

If you answer “YES” to all of these questions, you may attempt to extinguish the fire. Even if you answer “YES” to all of the questions but feel unable to extinguish the fire, you should leave immediately. You should always remember the 5-second rule.

If the fire is extinguished in 5 seconds and the area is safe, you should stay and overhaul the fire.

Overhauling is the process of searching a fire scene for hidden fire or sparks in an effort to prevent the fire from rekindling. Remember “cool, soak, and separate.”

COMMUNITY EMERGENCY RESPONSE TEAM
UNIT 2: FIRE SAFETY AND UTILITY CONTROLS

Deciding to Use a Fire Extinguisher

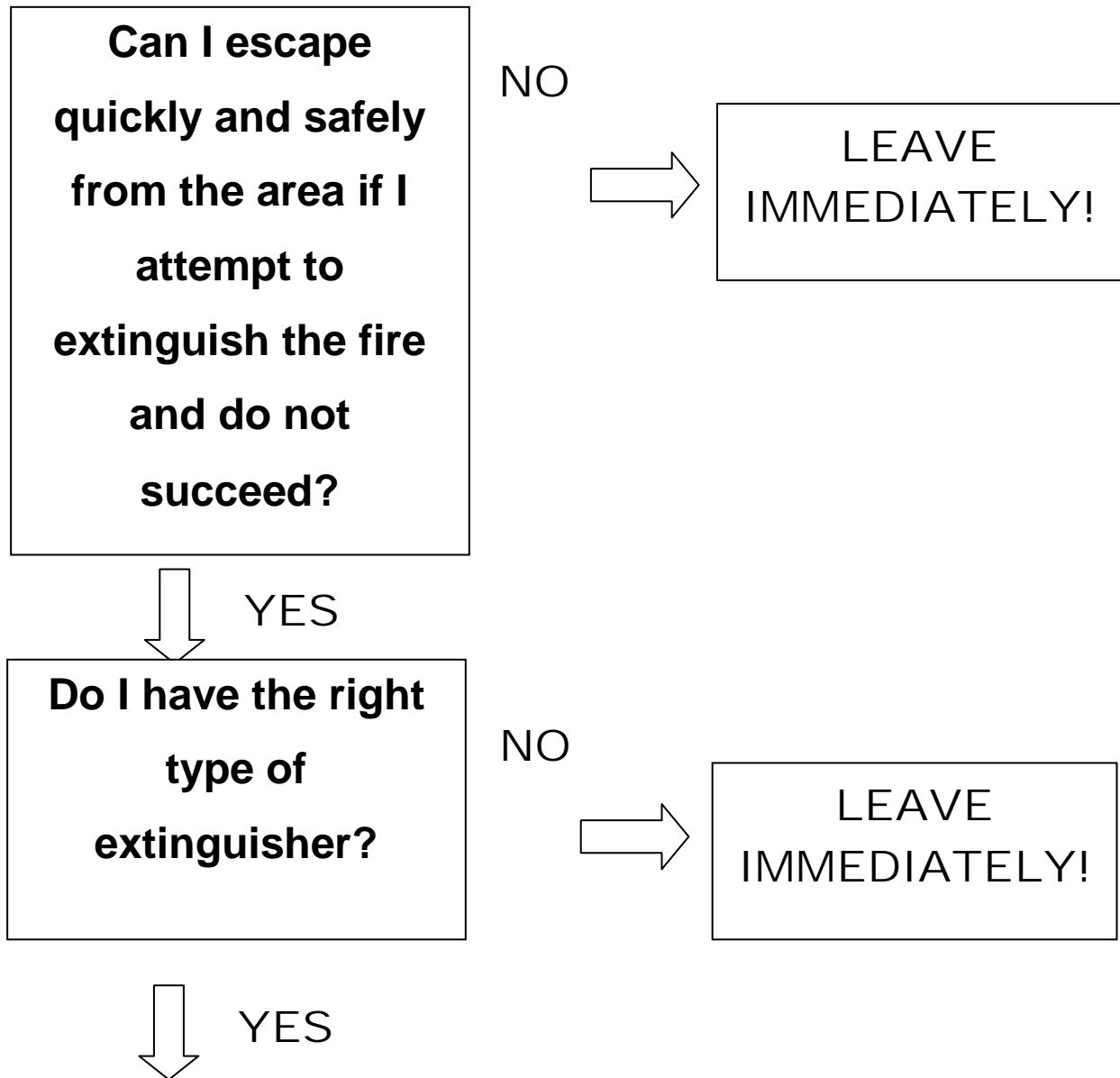

COMMUNITY EMERGENCY RESPONSE TEAM
UNIT 2: FIRE SAFETY AND UTILITY CONTROLS

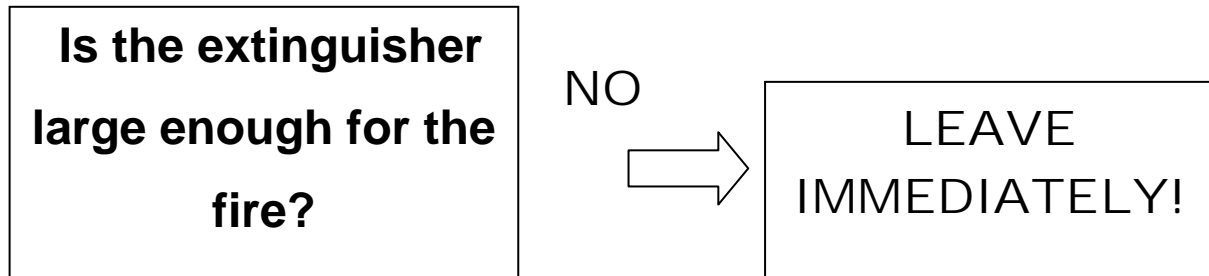

↓ YES

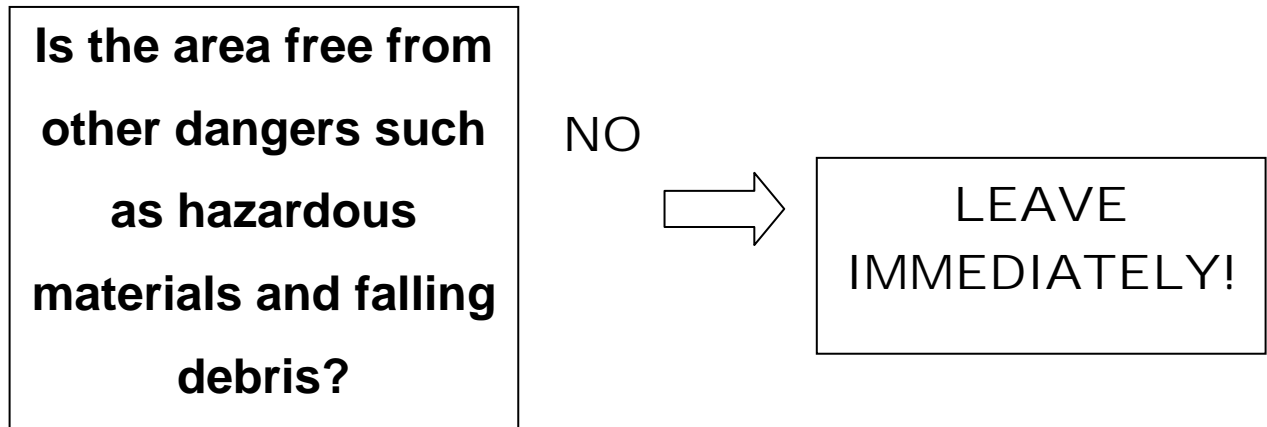

↓ YES

**START TO EXTINGUISH
THE FIRE**

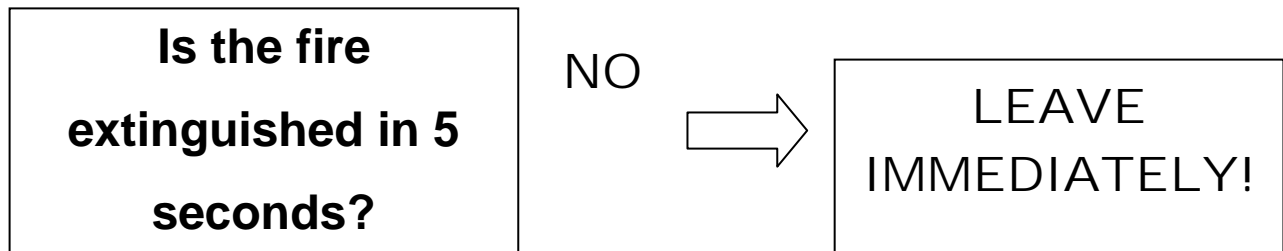

COMMUNITY EMERGENCY RESPONSE TEAM
UNIT 2: FIRE SAFETY AND UTILITY CONTROLS

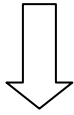

YES

**STAY AND OVERHAUL
THE FIRE IF THE AREA
IS SAFE**

COMMUNITY EMERGENCY RESPONSE TEAM
UNIT 2: FIRE SAFETY AND UTILITY CONTROLS

COMPONENTS OF A PORTABLE FIRE EXTINGUISHER

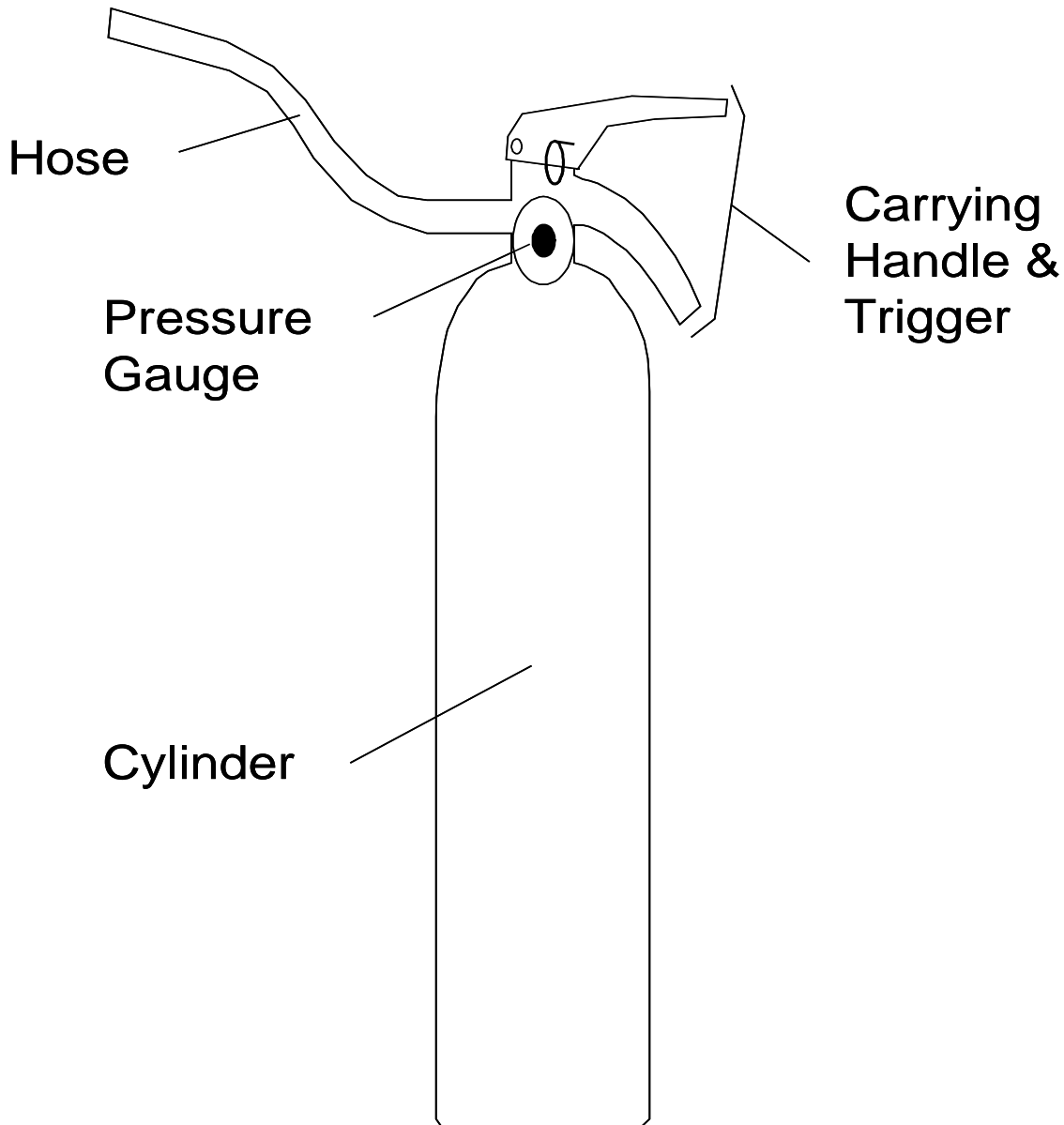

Components of a portable fire extinguisher: Hose, carrying handle and trigger, pressure gauge, cylinder

COMMUNITY EMERGENCY RESPONSE TEAM
UNIT 2: FIRE SAFETY AND UTILITY CONTROLS

P.A.S.S.

PULL

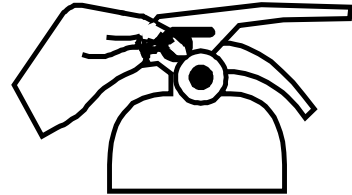
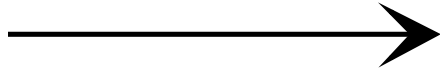

AIM

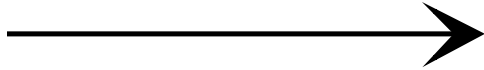

SQUEEZE

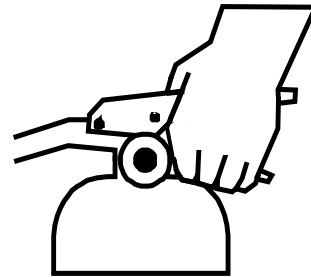
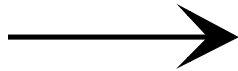

SWEEP

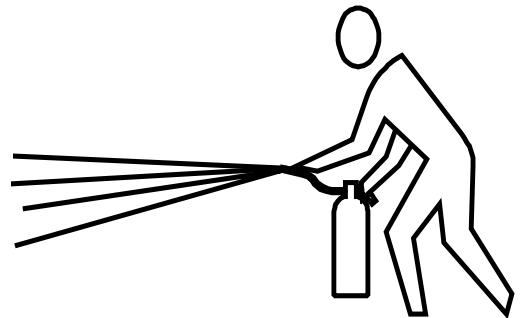
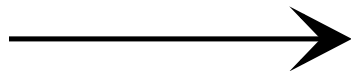

COMMUNITY EMERGENCY RESPONSE TEAM
UNIT 2: FIRE SAFETY AND UTILITY CONTROLS

Due to the dryness of the hose fabric, water may seep through the hose fabric until the hose is saturated. This may last for approximately 1 minute.

CONFINEMENT

In interior spaces, it is possible to *confine* a fire and restrict the spread of smoke and heat by closing doors, interior and exterior.

COMMUNITY EMERGENCY RESPONSE TEAM
UNIT 2: FIRE SAFETY AND UTILITY CONTROLS

provide help if you need it.

- **Always have two ways to exit the fire area.** Fires spread much faster than you might think. Always have a backup escape plan in case your main escape route becomes blocked.
- **Look at the door.** If air is being sucked under the door or smoke is coming out the top of the door, do **not touch** the door.
- **Feel closed doors with the back of the hand,** working from the bottom of the door up. Do **not** touch the door handle before feeling the door. If the door is hot, there is fire behind it. Do not enter! Opening the door will feed additional oxygen to the fire.
- **Confine the fire,** whenever possible, by closing doors and keeping them closed.
- **Stay low to the ground.** Smoke will naturally rise.

COMMUNITY EMERGENCY RESPONSE TEAM
UNIT 2: FIRE SAFETY AND UTILITY CONTROLS

that is clearly too large for the equipment at hand (i.e., a fire that is larger than the combined ratings of available fire extinguishers).

- **Enter smoke-filled areas.** Suppressing fires in smoke-filled areas requires equipment that CERTs don't have.

PROPER FIRE SUPPRESSION PROCEDURES

A buddy system is used in all cases.

- **The job of Team Member 1 is to put out a fire with an extinguisher.**
- **The job of Team Member 2 is to watch for hazards and ensure the safety of both team members.**

COMMUNITY EMERGENCY RESPONSE TEAM
UNIT 2: FIRE SAFETY AND UTILITY CONTROLS

- 4. Both team members should walk toward the fire. Team Member 1 should watch the fire and Team Member 2 should stay close to Team Member 1, keeping his or her hand on Team Member 1's shoulder. Team Member 2's job is to protect Team Member 1.**
- 5. When Team Member 1 is exiting the fire area, he or she should say, "Backing out." Team Member 2 should repeat the command.**
- 6. Team Member 2 should guide Team Member 1 from the area with his or her hands as Team Member 1 continues facing the fire and looking for other hazards. Team Member 1 must never turn his or her back on the fire scene.**

COMMUNITY EMERGENCY RESPONSE TEAM
UNIT 2: FIRE SAFETY AND UTILITY CONTROLS

- **Nonflammable gases**
- **Oxidizers**
- **Radioactive materials**

COMMUNITY EMERGENCY RESPONSE TEAM
UNIT 2: FIRE SAFETY AND UTILITY CONTROLS

- **Dry cleaner**
- **Funeral home**
- **Home supply store**
- **Big box store**
- **Delivery van (UPS, FedEx)**

Placards

The National Fire Protection Association (NFPA) 704 Diamond is a concise system for identifying the hazards associated with specific materials. The NFPA 704 Diamond placard is found on fixed facilities where hazardous materials are used or stored.

The diamond is divided into four colored quadrants, each with a rating number inside of it, which indicates the degree of risk associated with the material.

Numbers range from 1 to 4. The higher the number the higher the risk!

COMMUNITY EMERGENCY RESPONSE TEAM
UNIT 2: FIRE SAFETY AND UTILITY CONTROLS

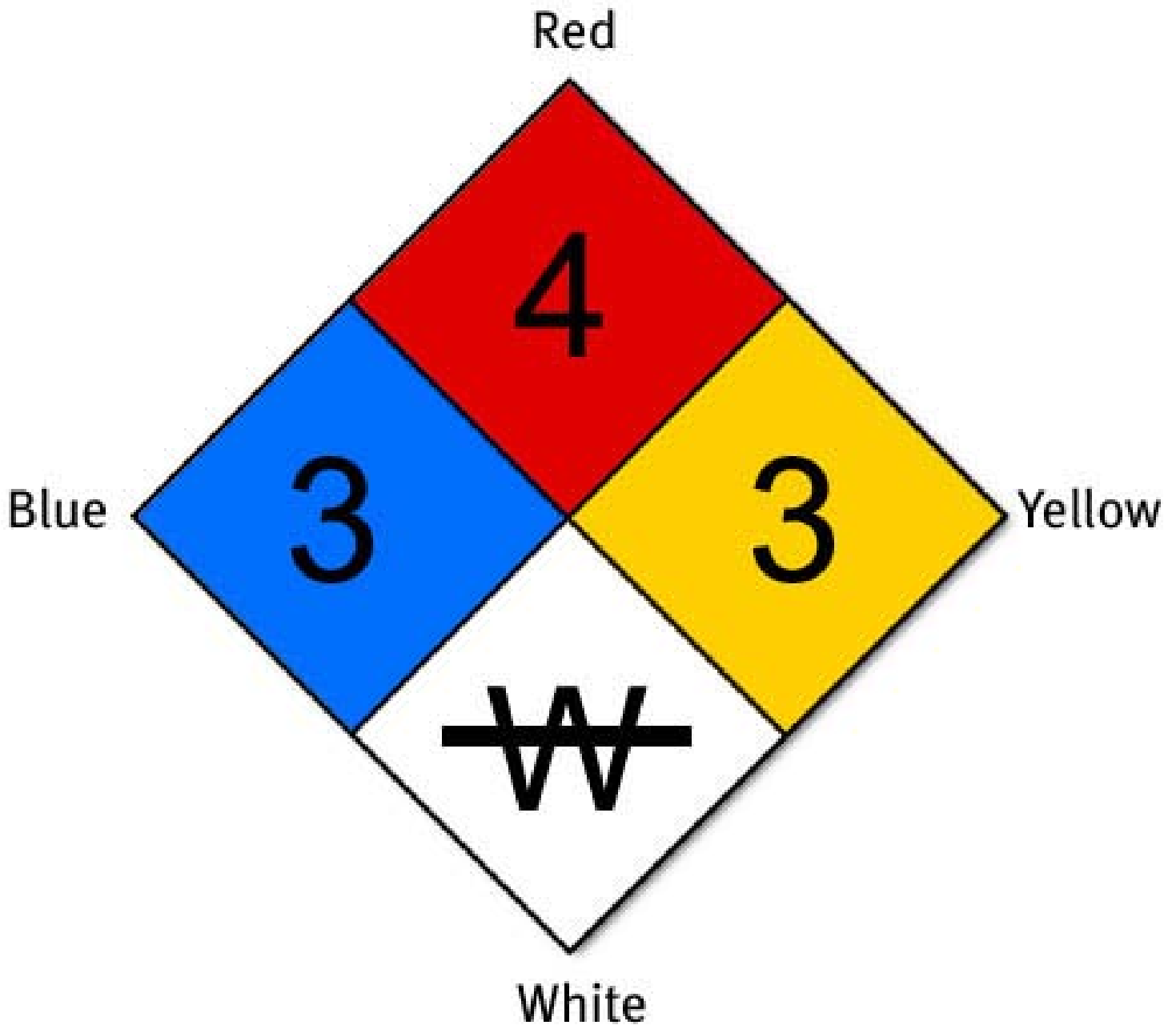

COMMUNITY EMERGENCY RESPONSE TEAM
UNIT 2: FIRE SAFETY AND UTILITY CONTROLS

- The red quadrant describes the material's flammability.
- The blue quadrant indicates health hazard.
- The yellow quadrant indicates reactivity.
- The white quadrant indicates special precautions.

There are two symbols specified in the National Fire Codes, section 704.

- W indicates a material that displays unusual reactivity with water (i.e., should never be mixed with water or have water sprayed on it). Magnesium metal is an example of a material that is reactive to water.

OX indicates a material that possesses oxidizing properties. Ammonium nitrate is an example of a material with oxidizing properties. Materials that are oxidizers increase the potential for explosion or fire.

COMMUNITY EMERGENCY RESPONSE TEAM
UNIT 2: FIRE SAFETY AND UTILITY CONTROLS

IDENTIFYING HAZARDOUS MATERIALS IN TRANSIT

There are three ways that hazardous materials are marked and identified while in transit:

- **The Department of Transportation (DOT) placard**
- **The United Nations (UN) system**
- **The North American (NA) warning placards**

These placards can be on any vehicle, not only tankers. Keep in mind that:

- **No placard is required for less than 1,000 pounds of many hazardous materials.**
- **Certain hazardous materials (e.g., anhydrous ammonia) are placarded as a nonflammable gas for domestic transport but as a flammable gas for international transport. (Anhydrous ammonia is a flammable gas!)**

COMMUNITY EMERGENCY RESPONSE TEAM
UNIT 2: FIRE SAFETY AND UTILITY CONTROLS

DOT PLACARD WARNING

Orange		Red & White		Black & White	
Red		Red		Yellow & White	
White		White		White	
Blue		Red		Yellow	
Blue		Blue		Blue	
Red & White		Red & White		Black & White	

COMMUNITY EMERGENCY RESPONSE TEAM
UNIT 2: FIRE SAFETY AND UTILITY CONTROLS

EXERCISE: SUPPRESSING SMALL FIRES

Purpose: This exercise will provide you with experience in two key areas of fire suppression:

- **Using a portable fire extinguisher to suppress a small fire**
- **Applying teamwork to fire suppression**

Instructions:

- 1. Identify possible exit routes, wind direction, and whether the fire is spreading.**

COMMUNITY EMERGENCY RESPONSE TEAM
UNIT 2: FIRE SAFETY AND UTILITY CONTROLS

4. **Team Member 1 should approach the fire from the windward side (i.e., with the wind to the team member's back). When approximately 10 feet from the fire, Team Member 1 should begin to discharge the extinguisher at the base of the fire, continuing the approach until the range for the extinguisher is optimal.**

5. **Team Member 1 should sweep the base of the fire until it is extinguished.**

6. **When Team Member 1 is ready to exit the fire area, he or she should say, "Backing out." Team Member 2 should repeat the command. Team Member 2 should guide Team Member 1 from the area with his or her hands as Team Member 1 continues facing the fire and looking for other hazards.**

COMMUNITY EMERGENCY RESPONSE TEAM
UNIT 2: FIRE SAFETY AND UTILITY CONTROLS

- **Class D: Combustible metals**

- **Class K: Cooking oils in commercial kitchens and cafeterias**

It is extremely important to identify the class of fire to use the proper extinguisher for the class.

Portable fire extinguishers are most frequently used for suppressing small fires. Their labels tell the types of fires for which they are effective and the area that they can suppress.

When using portable fire extinguishers, remember P.A.S.S.: Pull, Aim, Squeeze, and Sweep. Always test the extinguisher after pulling the pin.

When suppressing a fire, always follow the safety rules established for CERTs.

To help understand the types of materials, there are several methods of placarding hazardous materials being stored or transported, including NFPA, DOT,

COMMUNITY EMERGENCY RESPONSE TEAM
UNIT 2: FIRE SAFETY AND UTILITY CONTROLS

Be sure to wear comfortable clothes for the next session because you will be practicing medical techniques.

[This page intentionally left blank]